

MİMARİ KATALOG
ARCHITECTURAL CATALOGUE

Alüminyum Kapı Pencere ve Giydirme Cephe Sistemleri
Aluminium Window Doors and Facade Systems

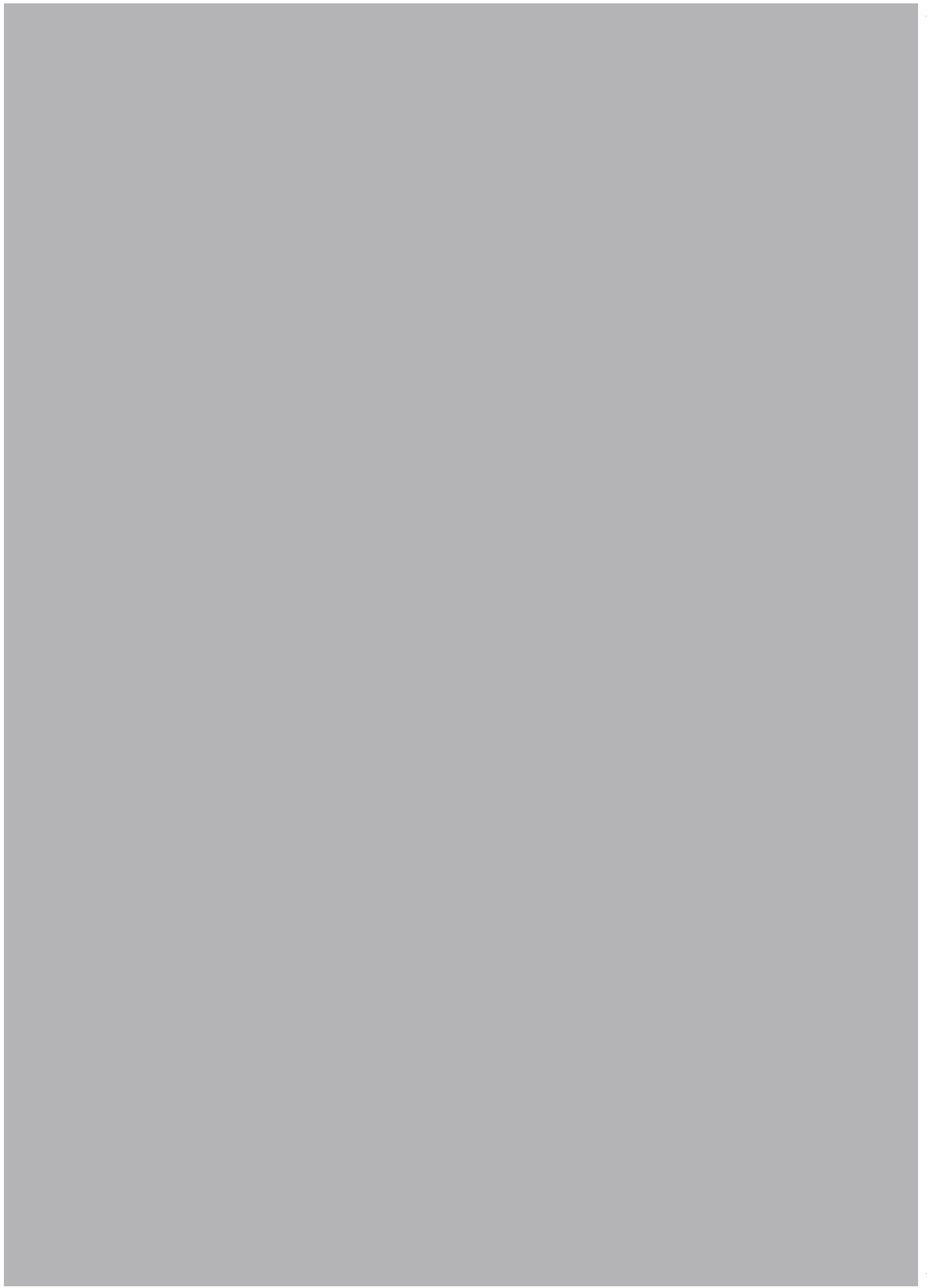

DÜZ ALDOKS



MİMARİ KATALOG ARCHITECTURAL CATALOGUE

Alüminyum Kapı Pencere ve Giydirme Cephe Sistemleri
Aluminium Window Doors and Facade Systems



Rescara Sistem Detayları
Rescara System Details

DÜZ ALDOKS

PROFİLLER

PROFILES

11

12

13

14

15

16

17

18

19

20

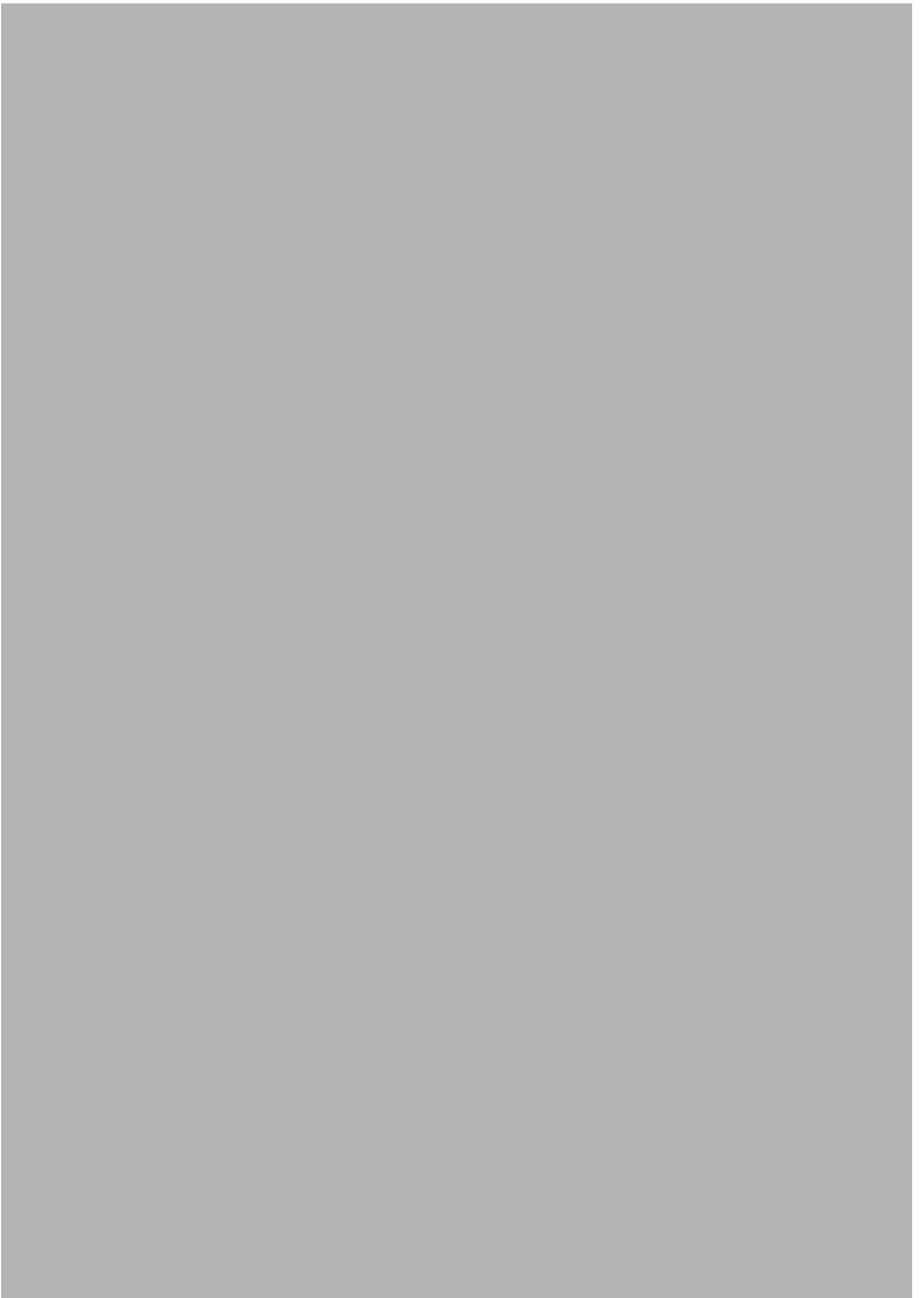

PROFİLLER
PROFILES

DÜZ ALDOKS

KOD / CODE	AĞIRLIK (kg/m) / WEIGHT	L m	KOD / CODE	AĞIRLIK (kg/m) / WEIGHT	L m
A000536	0,601	6	A000182	0,703	6
A000537	0,600	6	A000183	0,607	6
A000538	0,502	6	A000181	0,704	6

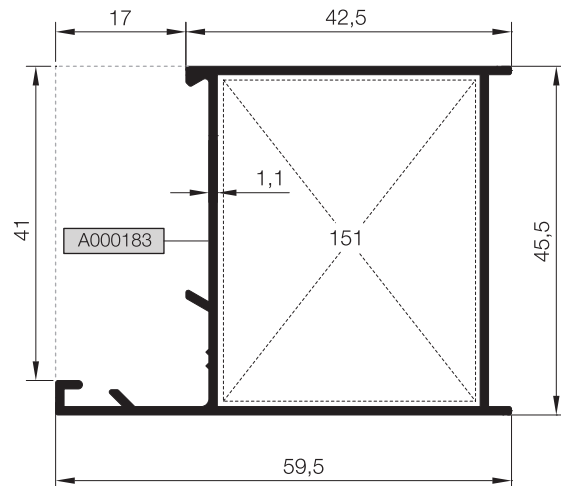
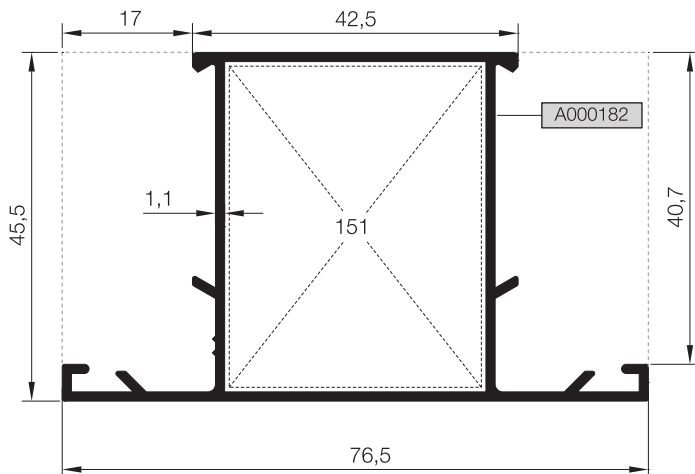
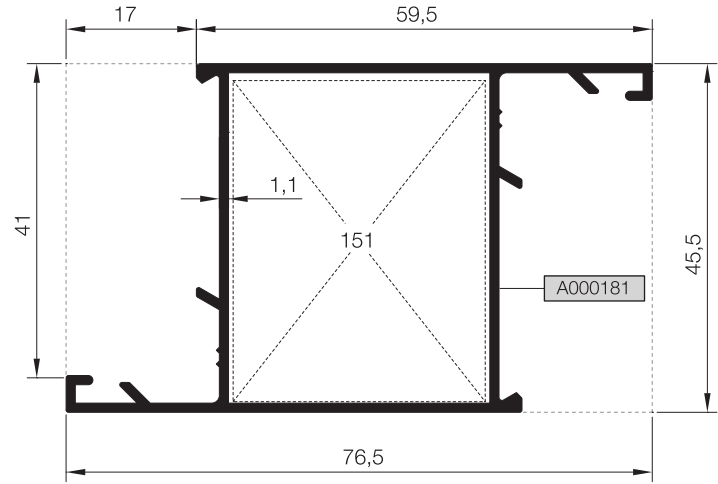
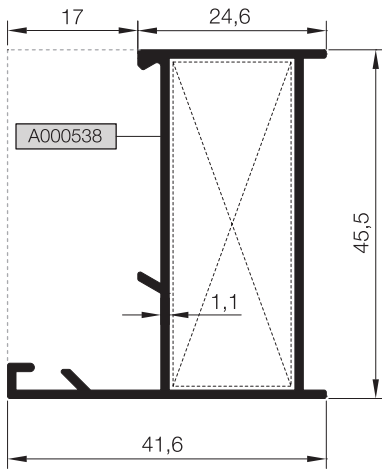
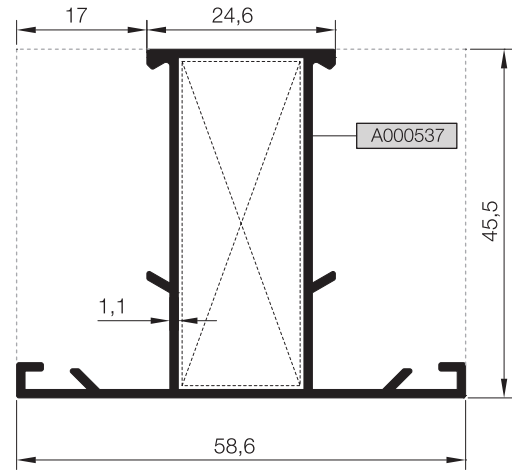
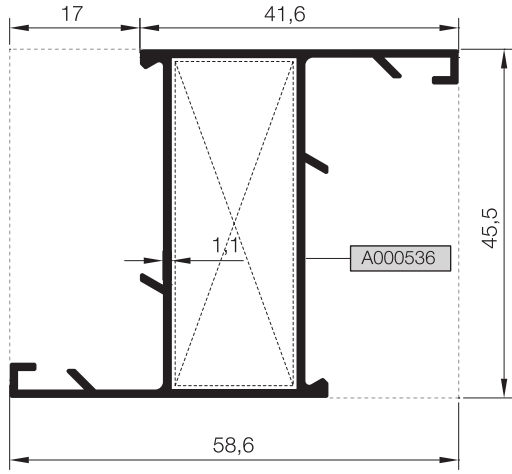

11

12

13

14

15

16

17

18

19

20

PROFİLLER
PROFILES

DÜZ ALDOKS

KOD / CODE	AĞIRLIK (kg/m) / WEIGHT	L m
A003292	1,242	6
A003293	1,135	6
A003294	1,137	6

11

12

13

14

15

16

17

18

19

20

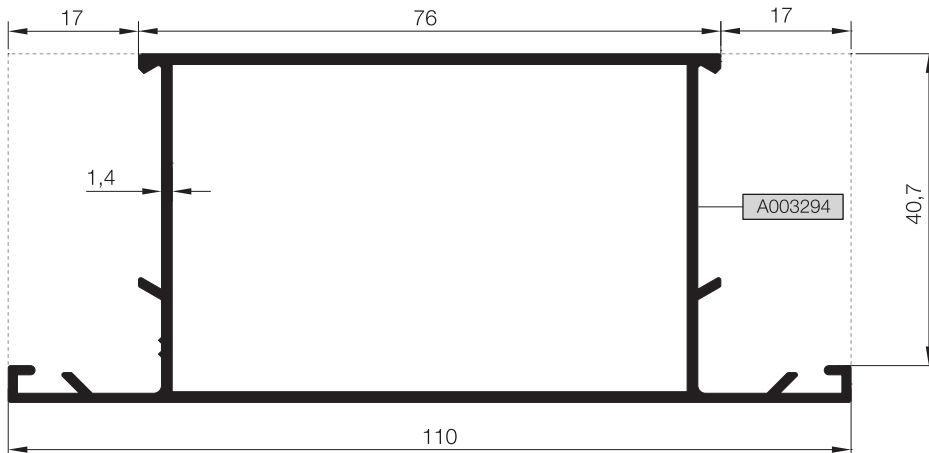
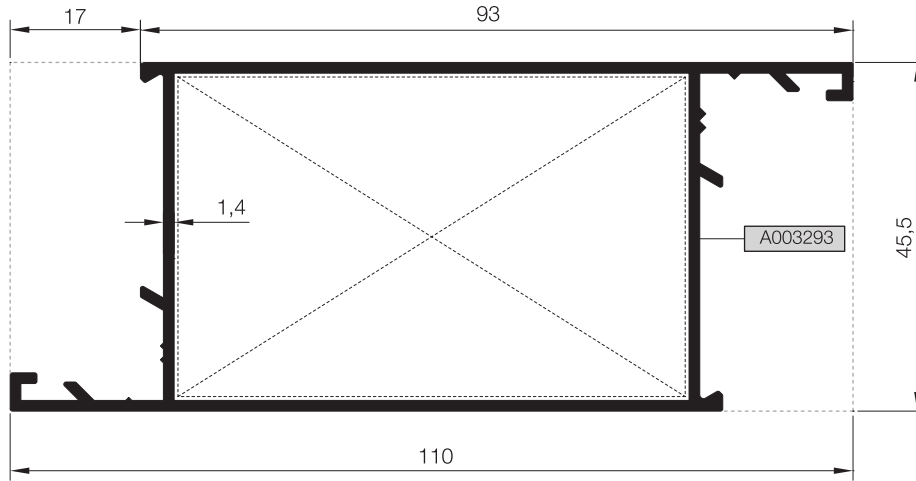
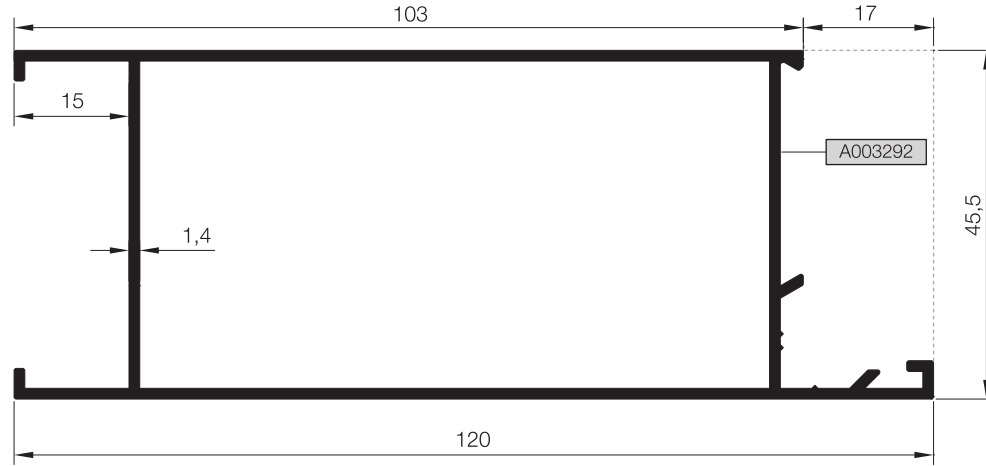

PROFİLLER
PROFILES

DÜZ ALDOKS

KOD / CODE	AĞIRLIK (kg/m) / WEIGHT	L m
A000184	1,733	6
A000185	1,876	6

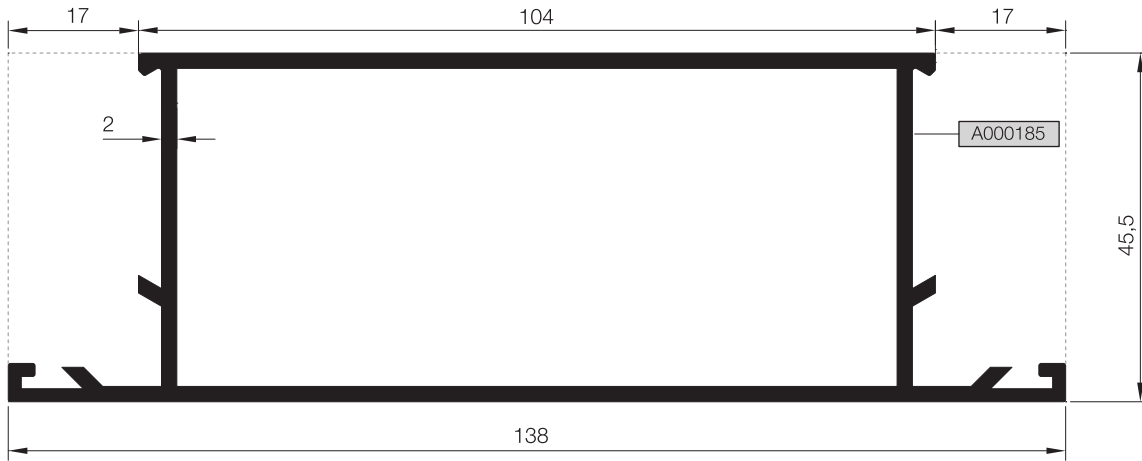
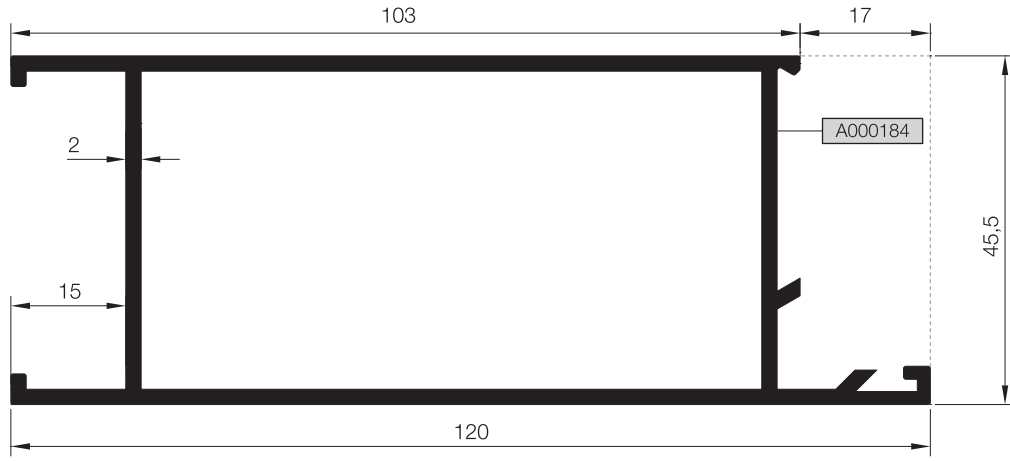

11

12

13

14

15

16

17

18

19

20

PROFİLLER
PROFILES

DÜZ ALDOKS

KOD / CODE	AĞIRLIK (kg/m) / WEIGHT	L m
A000110	1,835	6
A004306	0,786	6
A011190	0,848	6

11

12

13

14

15

16

17

18

19

20

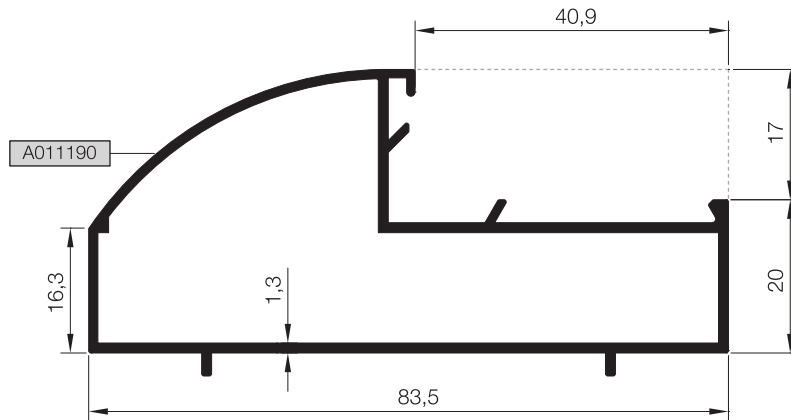
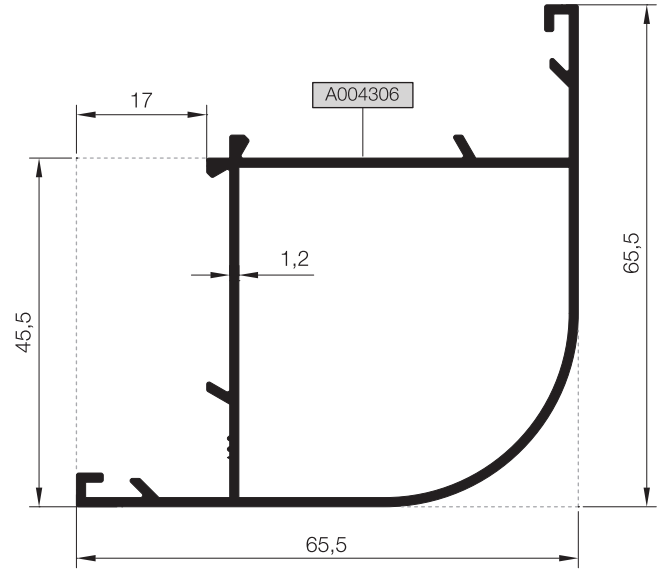
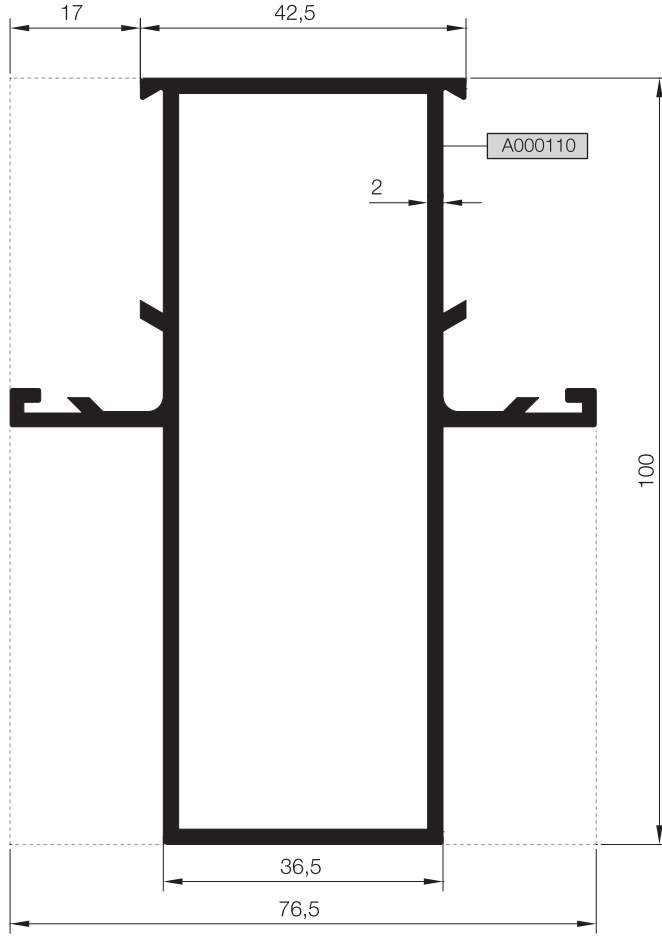

PROFİLLER
PROFILES

DÜZ ALDOKS

KOD / CODE	AĞIRLIK (kg/m) / WEIGHT	L m
A000151	1,157	6
A000152	0,890	6
A000154	0,593	6
A002729	0,363	6

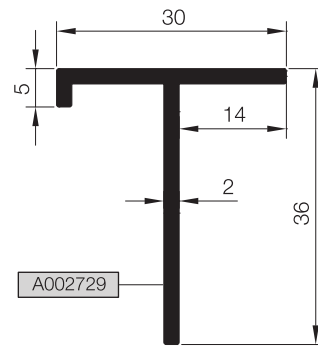
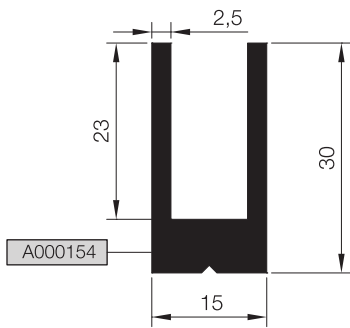
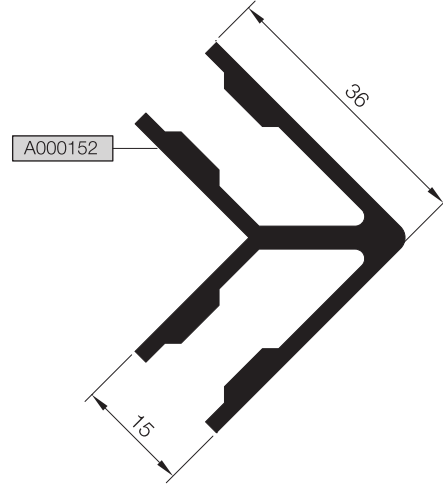
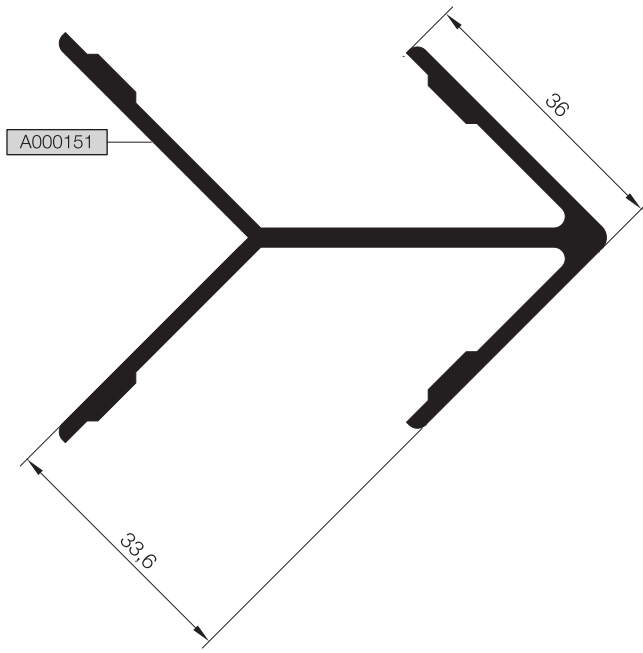

11

12

13

14

15

16

17

18

19

20

PROFİLLER
PROFILES

DÜZ ALDOKS

KOD / CODE	AĞIRLIK (kg/m) / WEIGHT	L m	KOD / CODE	AĞIRLIK (kg/m) / WEIGHT	L m
A000114	0,354	6	A000104	0,228	6
A000115	0,580	6	A000640	0,125	6
A000105	0,230	6	A000639	0,136	6

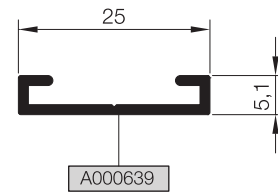
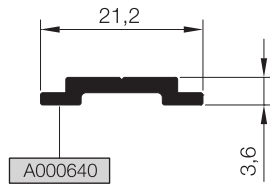
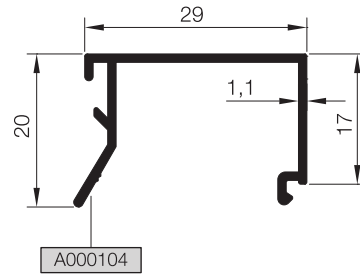
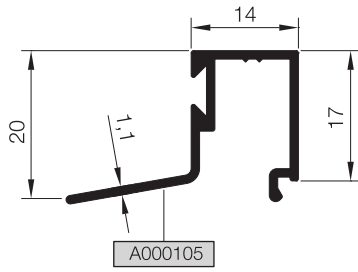
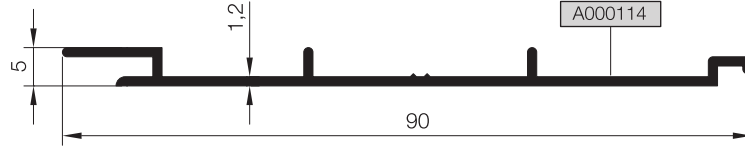

11

12

13

14

15

16

17

18

19

20

PROFİLLER
PROFILES

DÜZ ALDOKS

KOD / CODE	AĞIRLIK (kg/m) / WEIGHT	L m
A006908	0,533	6
A010980	0,268	6
A000158	0,201	6
A011793	0,485	6
A011794	0,297	6

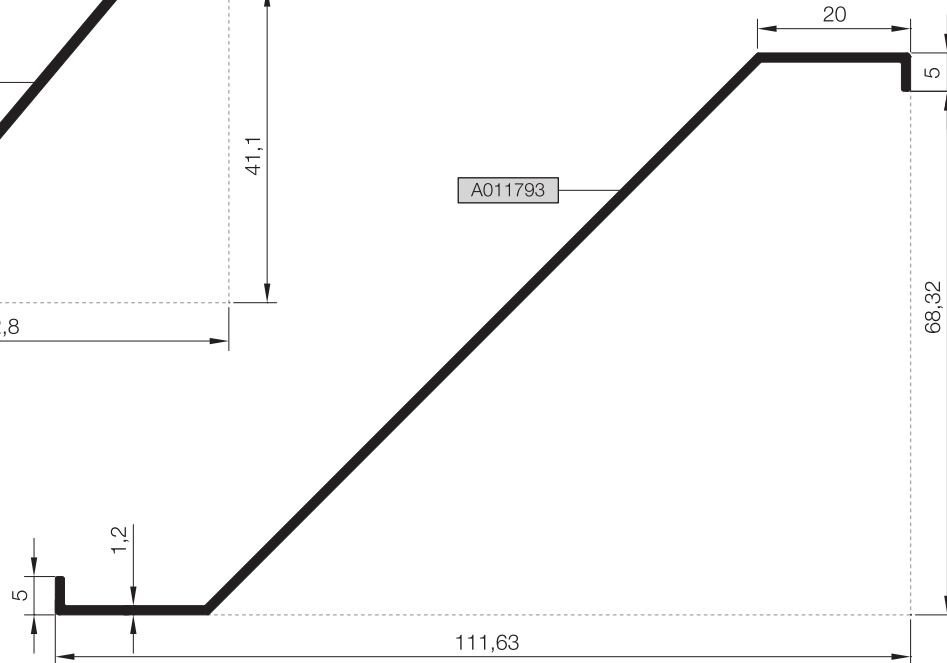
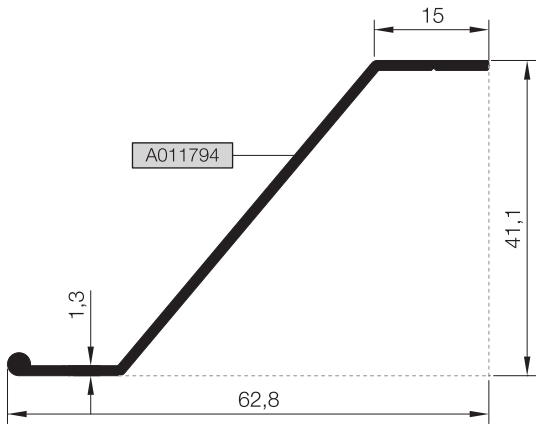
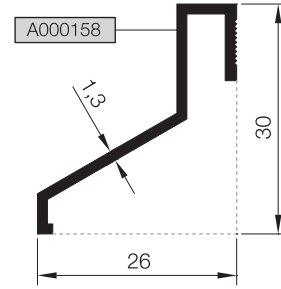
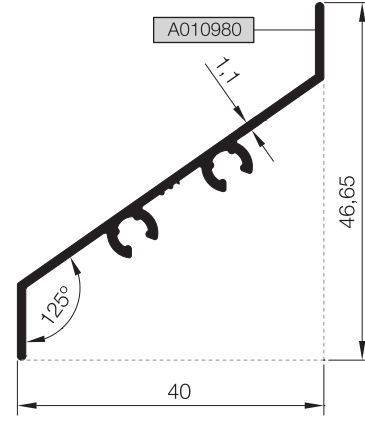
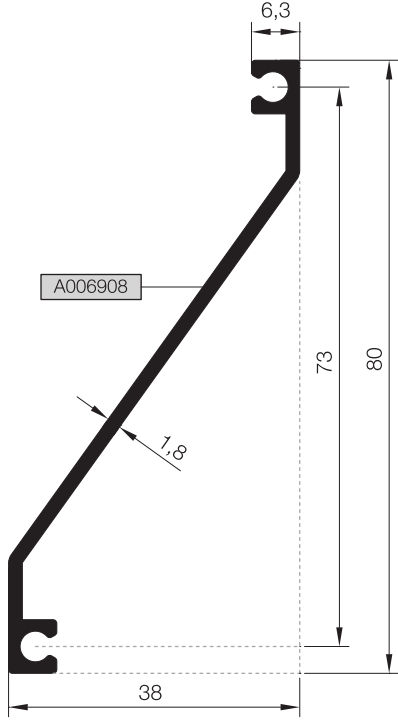

11

12

13

14

15

16

17

18

19

20

STOKTA BULUNAN SİSTEM PROFİLLERİNİN LİSTESİ (LIST OF SYSTEM PROFILES IN STOCK)

Nr	MIN. SİPARİŞ MİKTARI MIN. ORDER QUANTITY
A000104	75 kg
A000105	75 kg
A000151	75 kg
A000152	75 kg
A000158	75 kg
A000181	75 kg
A000182	75 kg
A000183	75 kg
A000536	75 kg
A000537	75 kg
A000538	75 kg
A000639	75 kg
A000640	75 kg
A003292	75 kg
A003293	75 kg
A003294	75 kg

* STOKTA BULUNMAYAN TÜM PROFİLLER İÇİN MINİMUM SİPARİŞ MİKTARI 300'KG'DİR.
MINIMUM ORDER QUANTITY FOR ALL THE PROFILES THAT ARE NOT IN STOCK IS 300 KG.

11

12

13

14

15

16

17

18

19

20

MİMARİ KATALOG ARCHITECTURAL CATALOGUE

Alüminyum Kapı Pencere ve Giydirme Cephe Sistemleri
Aluminium Window Doors and Facade Systems



Rescara Sistem Detayları
Rescara System Details

DÜZ ALDOKS

AKSESUARLAR

ACCESSORIES

11

12

13

14

15

16









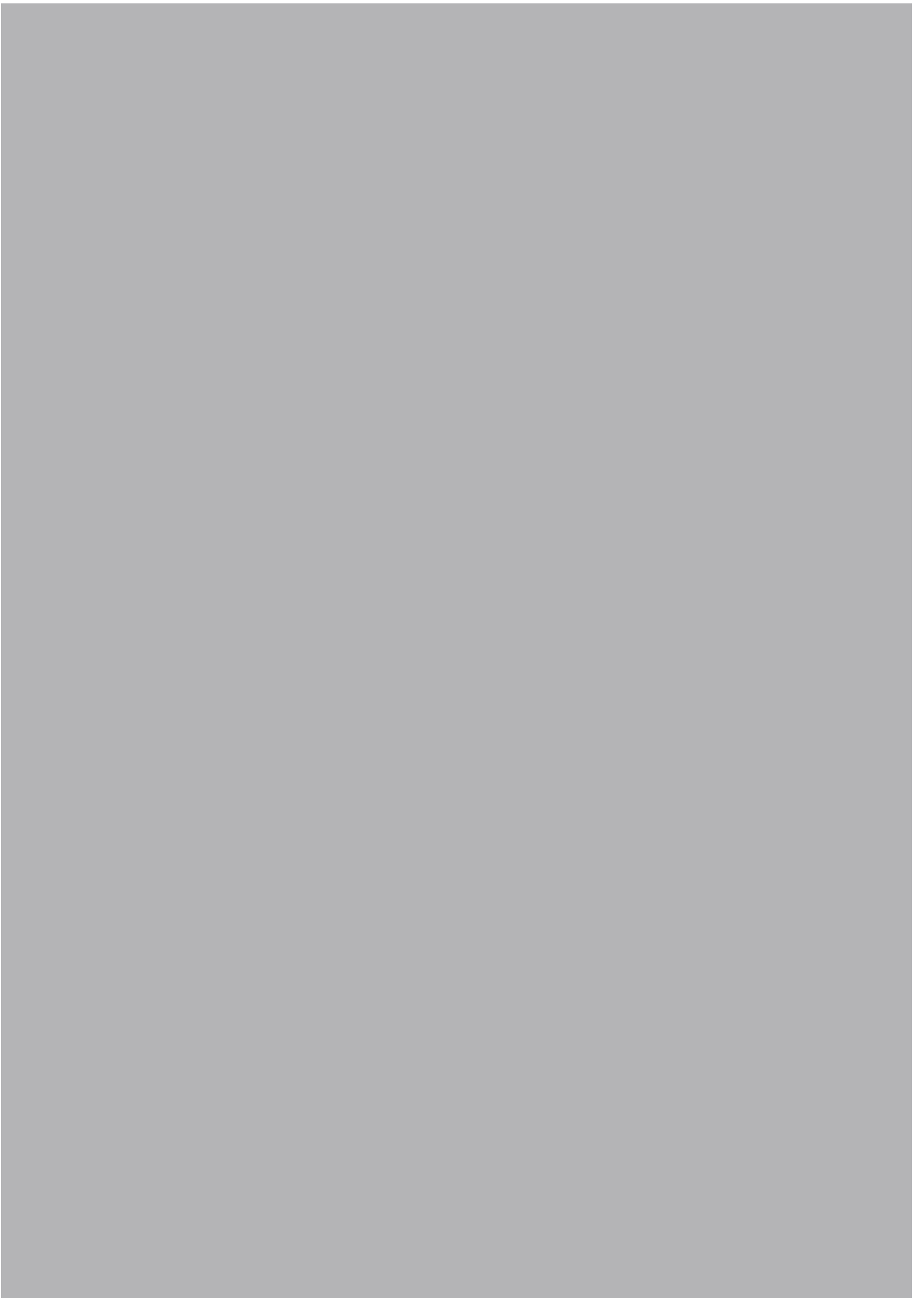

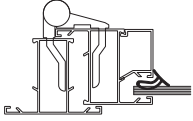

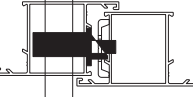

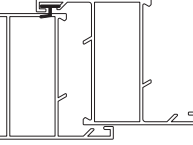
17

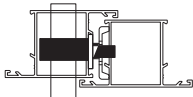
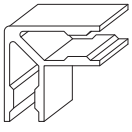
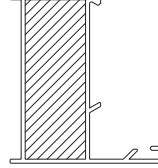
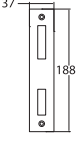
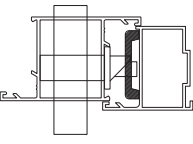
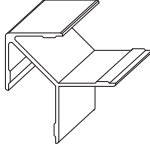
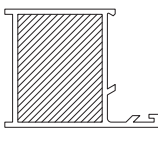
18

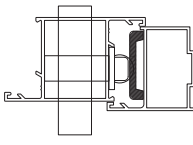
19

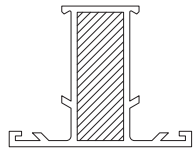
20

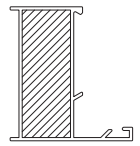

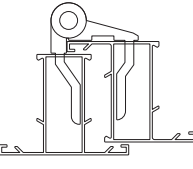
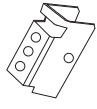
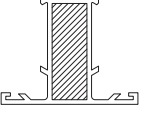
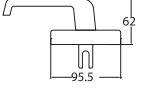
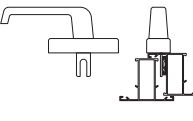
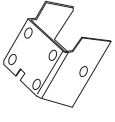
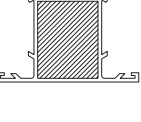
	<p>01.17.13 CAM FİTİLİ GLAZING GASKET</p> <p>Malzeme / Material : EPDM Ağırlık / Weight : 0,080 kg/m Paket / Package : -</p>			<p>18.01.04 DİLLİ KİLİT</p>	
	<p>01.18.26 KANAT FİTİLİ WING GASKET</p> <p>Malzeme / Material : EPDM Ağırlık / Weight : 0,025 kg/m Paket / Package : -</p>			<p>18.01.05 MAKARALI KİLİT</p>	
	<p>114 L 65 ALDOKS DAR KASA KANAT ORT. KAYIT KÖŞE TAKOZU</p> <p>Malzeme / Material : Alüminyum</p>			<p>18.02.15 DİLLİ KİLİT KARŞILIĞI</p>	
	<p>114 L 66 ALDOKS GENİŞ KASA KANAT ORT. KAYIT KÖŞE TAKOZU</p> <p>Malzeme / Material : Alüminyum</p>			<p>18.02.16 MAKARALI KİLİT KARŞILIĞI</p>	
	<p>114 J 14 ALDOKS DAR ORT. KAYIT BAĞLANTISI</p> <p>Malzeme / Material : Alüminyum</p>			<p>10.08.01 KÖŞE TAKOZU</p>	
	<p>15.01.10 DÜZ ALDOKS MENTEŞE</p> <p>Malzeme / Material : Alüminyum</p>			<p>10.08.02 ALDOKS DAR ORTA KAYIT BAĞLANTISI</p>	
	<p>07.05.21N EKSENEL KOL</p> <p>Malzeme / Material : Alüminyum</p>			<p>10.08.03 ALDOKS GENİŞ ORTA KAYIT BAĞLANTISI</p>	

11

12

13

14

15



16

17

18

19

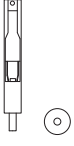
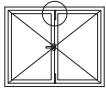
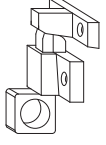
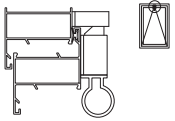
20

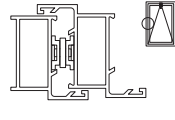
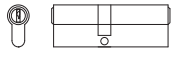
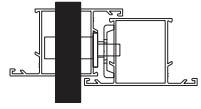
11		18.03.01 ALDOKS SÜRGÜ				
12						
13		07.08.03 VASISTAS MANDAL				
14						
15		07.07.06 VASISTAS MAKAS				
16		18.04.03 BAREL				
17						
18						
19						
20						

